



# BSP FITTINGS

PVC-U

Threaded fittings



# BSP FITTINGS

Series of fittings for pipes conveying fluids under pressure with threaded joints.

## THREADED FITTINGS

Technical specifications	
Size range	R 3/8" ÷ 4"
Nominal pressure	PN 16 with water at 20 °C
Temperature range	0 °C ÷ 60 °C
Coupling standards	<b>Thread:</b> ISO 228-1, DIN 2999, ISO 7, BS 21, ASTM D 2464, JIS B0203 <b>Flanging system:</b> DIN 2501, EN 1092-1
Reference standards	<b>Construction criteria:</b> EN ISO 1452, EN 15493 <b>Test methods and requirements:</b> EN ISO 1452, EN ISO 15493
Fittings material	PVC-U Grey RAL 7011
Seal material	EPDM, FKM

# TECHNICAL DATA

## PRESSURE VARIATION ACCORDING TO TEMPERATURE

For water and non-hazardous fluids for which the material is classified as CHEMICALLY RESISTANT (life expectancy 25 years). In other cases, a reduction of the nominal pressure PN is required.

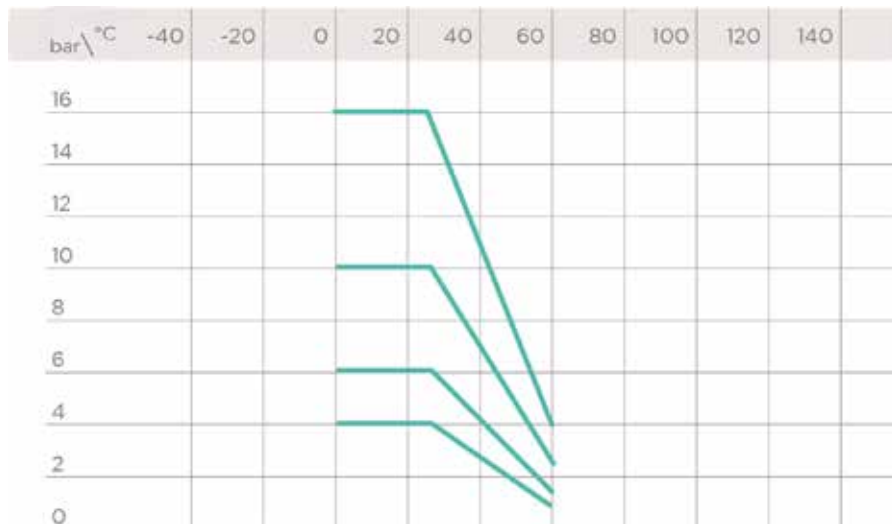

## REGRESSION CURVE FOR PVC-U FITTINGS

Regression coefficients according to EN ISO 1452 and EN ISO 15493 for MRS (minimum required strength) values = 25 N/mm<sup>2</sup> (MPa) (classification PVC-U 250)

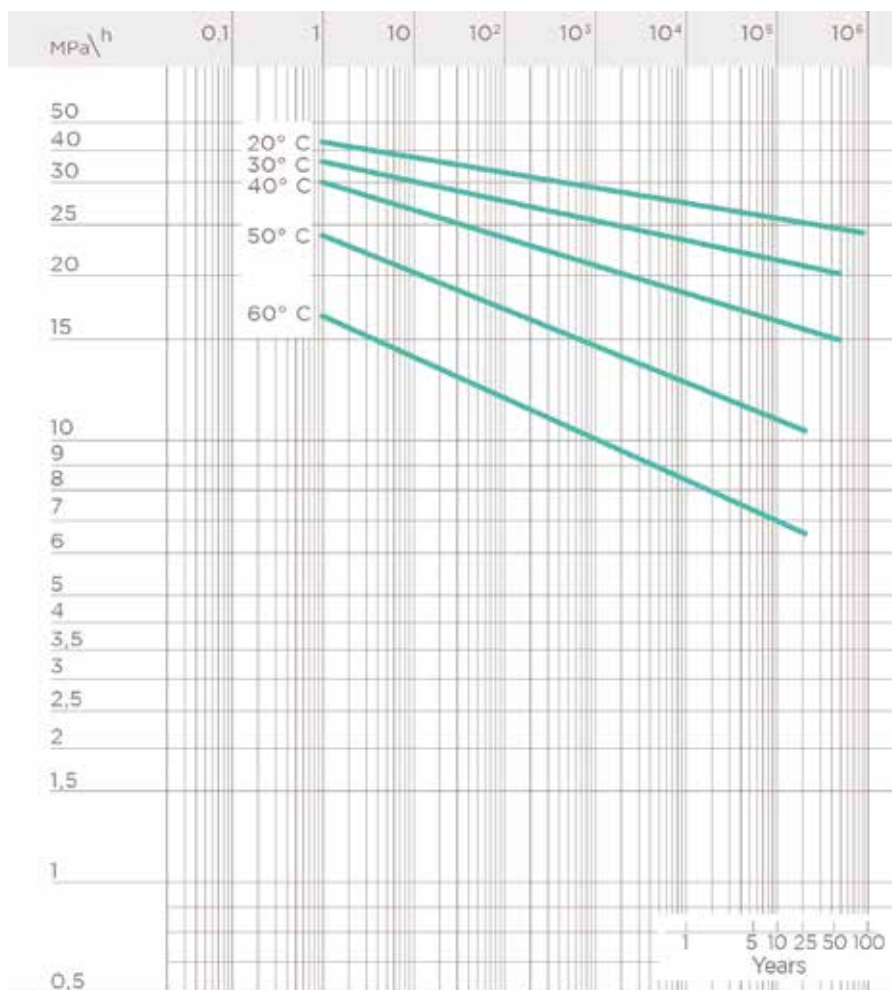

## SAFETY FACTORS

The table reports the safety factors for each pressure class as a function of time.

Nominal pressure PN must be understood as being the standard pressure used for calculating and selecting the required fittings. In order to be able to comply with the safety factors, the maximum continuous working pressure at 20° C when conveying water must be the same as the nominal pressure values. Unless otherwise specified, the nominal pressures are as follows:

- solvent weld fittings from d 12 to d 225 PN 16 from d 250 to d 315 PN 10
- adaptor fittings from d 16 to d 110 PN 16
- threaded fittings from R 3/8" to R 4" up to PN 16.

Pe (bar)	1h	1000h	50 years	T
10	6,72	5,12	4	
16	4,2	3,2	2,5	

# DIMENSIONS

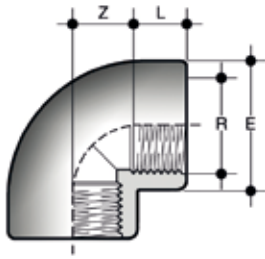

## GFV

90° elbow with BSP threaded female ends

R	PN	E	L	Z	g	Code
3/8"	16	23,5	11,4	13	16	GFV038
1/2"	16	28,5	15	13	24	GFV012
3/4"	16	35	16,3	17	40	GFV034
1"	16	43	19,1	21	72	GFV100
1 1/4"	16	54	21,4	27	130	GFV114
1 1/2"	16	61	21,4	36	185	GFV112
2"	16	76	25,7	46	350	GFV200
2 1/2"	16	91	30,2	55	450	GFV212
3"	16	108	33,3	66	835	GFV300
4"	16	130	39,3	80	1135	GFV400

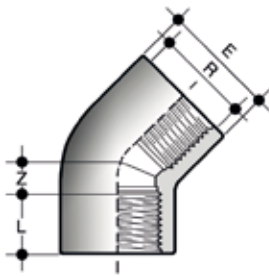

## HFV

45° elbow with BSP threaded female ends

R	PN	E	L	Z	g	Code
1/2"	16	28	15	6,5	18	HFV012
3/4"	16	33	16,3	8	24	HFV034
1"	16	41	19,1	10,5	45	HFV100
1 1/4"	16	50	21,4	15	68	HFV114
1 1/2"	16	64	21,4	21	154	HFV112
2"	16	76	25,7	26	255	HFV200
2 1/2"	16	90	30,2	31	345	HFV212
3"	16	107	33,3	39	625	HFV300

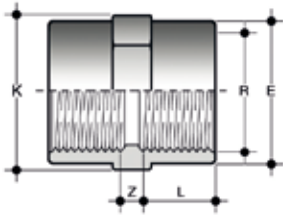

## MFV

Double socket with BSP threaded female ends

R	PN	E	K	L	Z	g	Code
3/8"	16	23,5	24	11,4	8	10	MFV038
1/2"	16	28,5	29	15	7	17	MFV012
3/4"	16	35	35	16,3	8,5	26	MFV034
1"	16	43	43	19,1	9	42	MFV100
1 1/4"	16	50	50	21,4	11	53	MFV114
1 1/2"	16	61	61	21,4	17,5	108	MFV112
2"	16	76	76	25,7	19,5	190	MFV200
2 1/2"	16	90	90	30,2	31	275	MFV212
3"	16	108	108	33,3	40,5	500	MFV300
4"	16	131	131	39,3	48,5	665	MFV400

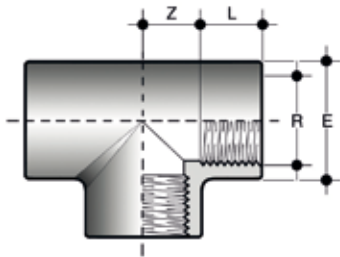

## TFV

90° Tee with BSP threaded female ends

R	PN	E	L	Z	g	Code
3/8"	16	23,5	11,4	13	20	TFV038
1/2"	16	28,5	15	13	32	TFV012
3/4"	16	35	16,3	17	52	TFV034
1"	16	43	19,1	21,5	92	TFV100
1 1/4"	16	50	21,4	27	117	TFV114
1 1/2"	16	61	21,4	37	260	TFV112
2"	16	76	25,7	46	465	TFV200
2 1/2"	16	91	30,2	55	640	TFV212
3"	16	109	33,3	66	1135	TFV300
4"	16	133	39,3	83	1710	TFV400

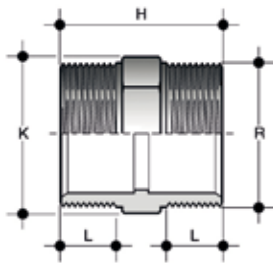

## NFV

Barrel nipple with BSP threaded male ends

R	PN	E	H	K	L	g	Code
3/8"	16	22	33	19	11,4	5	NFV038
1/2"	16	28	42	24	15	10	NFV012
3/4"	16	34	44	30	16,3	20	NFV034
1"	16	40	50	36	19,1	30	NFV100
1 <sup>1</sup> / <sub>4</sub> "	16	52	58	46	21,4	45	NFV114
1 <sup>1</sup> / <sub>2</sub> "	16	58	58	50	21,4	63	NFV112
2"	16	70	66	65	25,7	105	NFV200
*2 <sup>1</sup> / <sub>2</sub> "	16	-	78	80	30,2	175	NFV212
*3"	16	-	85	95	33,3	245	NFV300
*4"	16	-	90	120	39,3	348	NFV400

\* Reduced safety factor

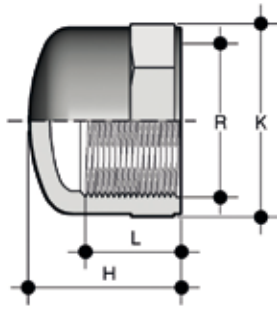

## CFV

End cap with BSP female thread

R	PN	H	K	L	g	Code
3/8"	16	19	23	11,4	6	1RCA216000
1/2"	16	25	28	15	10	CFV012
3/4"	16	27	34	16,3	15	CFV034
1"	16	31	42	19,1	27	CFV100
1 1/4"	16	35	51	21,4	40	CFV114
1 1/2"	16	36	58	21,4	53	CFV112
2"	16	42	71	25,7	85	CFV200
3"	16	55	109	33,3	310	CFV300

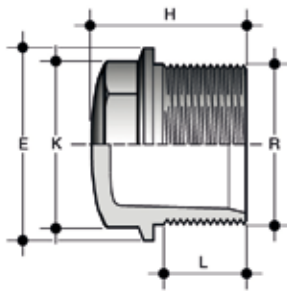
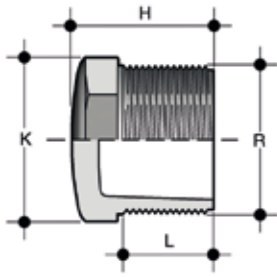

Fig. A Plug with BSP male thread (Fig. A)

## PFV

R	PN	E	H	K	L	g	Code
3/8"	16	22	22	18	11,4	4	PFV038
1/2"	16	28	26	23	15	8	PFV012
3/4"	16	34	30	28	16,3	11	PFV034
1"	16	40	34	35	19,1	21	PFV100
1 1/4"	16	52	38	44	21,4	30	PFV114
1 1/2"	16	58	40	51	21,4	46	PFV112
2"	16	70	47	64	25,7	74	PFV200





**Fig. B** **PFV** Plug with BSP male thread (Fig. B)

R	PN	E	H	K	L	g	Code
2 1/2"	16	-	61	80	30,2	180	PFV212
3"	16	-	71	93	33,3	245	PFV300
4"	16	-	87	118	39,3	550	PFV400

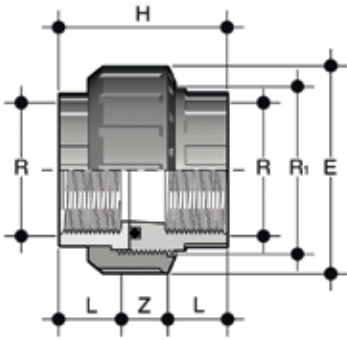

## BFV

Union with BSP threaded female ends, O-Ring in EPDM or FKM

R	R <sub>1</sub>	PN	E	H	L	Z	g	Code
3/8"	3/4"	16	33	40	11.4	17.2	22	BFV038E
1/2"	1"	16	41	46	15	16	35	BFV012E
3/4"	1 1/4"	16	50	51	16.3	18.4	65	BFV034E
1"	1 1/2"	16	58	57	19,10	18.8	85	BFV100E
1 1/4"	2"	16	72	65	21.4	22.2	145	BFV114E
1 1/2"	2 1/4"	16	79	65	21.4	22.2	180	BFV112E
2"	2 3/4"	16	98	78	25.7	26.6	325	BFV200E

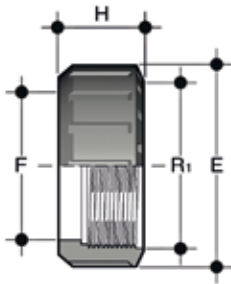

## EFV

Union nut with BSP thread for union types BIV, BIFV, BFV, BLV, BIRV, BIFOV, BIROV, BIFXV, BIRXV

R <sub>1</sub>	d BIV	PN	E	F	H	g	Code
1/2"	-	16	27	17	24	8	EFV012
3/4"	16	16	33	22	21	9	EFV034
1"	20	16	41	28	22	13	EFV100
1 1/4"	25	16	50	36	25	22	EFV114
1 1/2"	32	16	58	42	27	30	EFV112
2"	40	16	72	53	30	50	EFV200
2 1/4"	50	16	79	59	34	68	EFV214
2 1/2"	-	16	90	68	36	95	EFV212
2 3/4"	63	16	98	74	38	120	EFV234
3 1/2"	75	10	120	93	45	198	EFV312
4"	90	10	135	106	52	278	EFV400
5"	110	10	163	129	60	448	EFV500

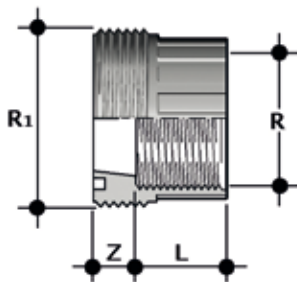

## F/BFV

Union bush with BSP threaded female end for union types BIV, BIFV, BFV, BLV, BIRV, BIFOV, BIROV, BIFXV, BIRXV

R	R <sub>1</sub>	PN	L	Z	g	Code
3/8"	3/4"	16	11,4	12,6	8	FBFV038
1/2"	1"	16	15	11	13	FBFV012
3/4"	1 1/4"	16	16,3	12,7	22	FBFV034
1"	1 1/2"	16	19,1	12,9	32	FBFV100
1 1/4"	2"	16	21,4	16,6	57	FBFV114
1 1/2"	2 1/4"	16	21,4	16,5	64	FBFV112
2"	2 3/4"	16	25,7	20,5	122	FBFV200

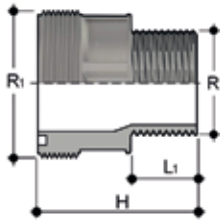

### F/BRV

Union bush with BSP threaded male end for union types BIV, BIFV, BFV, BLV, BIRV, BIFOV, BIROV, BIFXV, BIRXV

R	R <sub>1</sub>	PN	L <sub>1</sub>	g	Code
1 1/2"	2 1/4"	16	22,5	100	FBRV112214
2"	2 1/4"	16	27	120	FBRV200214
2"	2 3/4"	16	27	175	FBRV200234

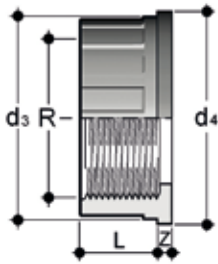

### Q/BFV

Union end with BSP female thread for union types BIV, BIFV, BFV, BLV, BIRV, BIFOV, BIROV, BIFXV, BIRXV

R	PN	d <sub>3</sub>	d <sub>4</sub>	L	Z	g	Code
3/8"	16	22	24	11,4	4,5	4,5	QBFV038
1/2"	16	27,5	30,1	15	5	8,5	QBFV012
3/4"	16	36	38,8	16,3	5	15,5	QBFV034
1"	16	41,5	44,7	19,1	5,5	21,0	QBFV100
1 1/4"	16	53	56,5	21,4	5,5	33,5	QBFV114
1 1/2"	16	59	62,6	21,4	5,5	40,0	QBFV112
2"	16	74	78,4	25,7	5,5	72,0	QBFV200

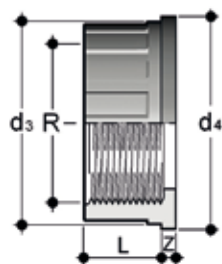

## Q/BNV

Union end with NPT female thread for union types BIV, BIFV, BFV, BLV, BIRV, BIFOV, BIROV, BIFXV, BIRXV

R	PN	$d_3$	$d_4$	L	Z	g	Code
3/8"	16	22	24	12,7	6,3	10	QBNV038
1/2"	16	27,5	30,1	17,8	5,2	15	QBNV012
3/4"	16	36	38,8	18	5,2	20	QBNV034
1"	16	41,5	44,7	22,6	5,7	30	QBNV100
1 1/4"	16	53	56,5	25,1	7,3	55	QBNV114
1 1/2"	16	59	62,6	24,7	7	70	QBNV112
2"	16	74	78,4	29,6	7,8	115	QBNV200

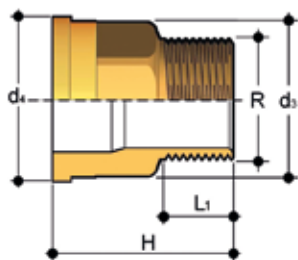

## Q/BRO

Union end in brass with male BSP thread for union types BIV, BIFV, BFV, BLV, BIRV, BIFOV, BIROV, BIFXV, BIRXV

R	$d_3$	$d_4$	H	$L_1$	g	Code
3/8"	22	24	34,5	10,5	64	QBRO038
1/2"	27,5	30,1	39	13,5	105	QBRO012
3/4"	36	38,8	43,5	15	184	QBRO034
1"	41,5	44,7	48	17,5	251	QBRO100
1 1/4"	53	56,5	53	19,5	437	QBRO114
1 1/2"	59	62,6	56	19,5	545	QBRO112
2"	74	78,4	65,5	24	937	QBRO200

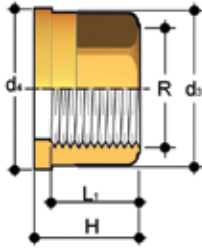

### Q/BFO

Union end in brass with female BSP thread for union types BIV, BIFV, BFV, BLV, BIRV, BIFOV, BIROV, BIFXV, BIRXV

R	d <sub>2</sub>	d <sub>3</sub>	H	L <sub>1</sub>	g	Code
3/8"	22	24	21,5	13,5	38	QBFO038
1/2"	27,5	30,1	22,5	16,5	60	QBFO012
3/4"	36	38,8	25,5	18,5	116	QBFO034
1"	41,5	44,7	27,5	19,5	144	QBFO100
1 1/4"	53	56,5	30,5	21,5	260	QBFO114
1 1/2"	59	62,6	33,5	23	325	QBFO112
2"	74	78,4	38,5	27	578	QBFO200

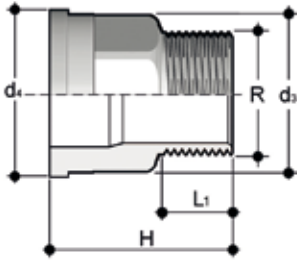

### Q/BRX

Union end in A316L stainless steel with male BSP thread for union types BIV, BIFV, BFV, BLV, BIRV, BIFOV, BIROV, BIFXV, BIRXV

R	d <sub>2</sub>	d <sub>3</sub>	H	L <sub>1</sub>	g	Code
3/8"	22	24	34,5	10,5	58	QBRX038
1/2"	27,5	30,1	39	13,5	95	QBRX012
3/4"	36	38,8	43,5	15	166	QBRX034
1"	41,5	44,7	48	17,5	226	QBRX100
1 1/4"	53	56,5	53	19,5	393	QBRX114
1 1/2"	59	62,6	56	19,5	491	QBRX112
2"	74	78,4	65,5	24	843	QBRX200

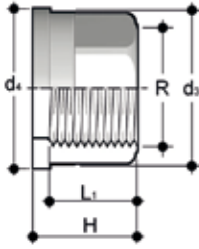

## Q/BFX

Union end in A316L stainless steel with female BSP thread for union types BIV, BIFV, BFV, BLV, BIRV, BIFOV, BIROV, BIFXV, BIRXV

R	d <sub>2</sub>	d <sub>1</sub>	H	L <sub>1</sub>	g	Code
3/8"	22	24	21,5	13,5	34	QBFX038
1/2"	27,5	30,1	22,5	16,5	54	QBFX012
3/4"	36	38,8	25,5	18,5	104	QBFX034
1"	41,5	44,7	27,5	19,5	130	QBFX100
1 1/4"	53	56,5	30,5	21,5	234	QBFX114
1 1/2"	59	62,6	33,5	23	293	QBFX112
2"	74	78,4	38,5	27	520	QBFX200

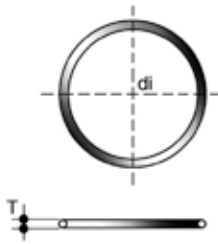

## O-RING

O-ring for union types BIV, BIFV, BFV, BLV, BIRV, BIFOV, BIROV, BIFXV, BIRXV

Union D	C	di	T	EPDMCode	FKM code
16	3062	15,54	2,62	OR3062E	OR3062F
20	4081	20,22	3,53	OR4081E	OR4081F
25	4112	28,17	3,53	OR4112E	OR4112F
32	4131	32,93	3,53	OR4131E	OR4131F
40	6162	40,65	5,34	OR6162E	OR6162F
50	6187	47	5,34	OR6187E	OR6187F
63	6237	59,69	5,34	OR6237E	OR6237F
75	6300	75,57	5,34	OR6300E	OR6300F
90	6362	91,45	5,34	OR6362E	OR6362F
110	6450	113,67	5,34	OR6450E	OR6450F

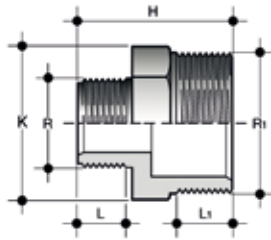

## NRFV

Reducing barrel nipple with BSP threaded male ends

R <sub>1</sub> x R	PN	H	K	L	L <sub>1</sub>	g	Code
3/4" x 1/2"	16	43	30	15	16,3	15	NRFV034012
1" x 3/4"	16	47	36	16,3	19,1	25	NRFV100034
1"1/4 x 1"	16	54	46	19,1	21,4	40	NRFV114100
1"1/2 x 1"1/4	16	60	50	21,4	21,4	60	NRFV112114
2" x 1"1/2	16	62	65	21,4	25,7	90	NRFV200112
2"1/2 x 2"	16	72	80	25,7	30,2	155	NRFV212200
3" x 2"1/2	16	82	95	30,2	33,3	240	NRFV300212
4" x 3"	16	91	120	33,3	39,3	357	NRFV400300

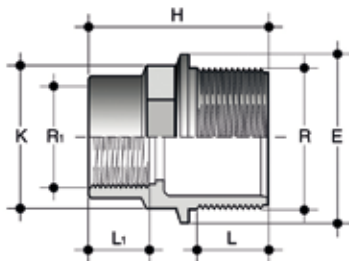

## RFV

Fig. A Reducer with BSP threaded male end (R) and BSP threaded female end (R1 reduced) (fig. A)

R x R <sub>1</sub>	PN	E	H	K	L	L <sub>1</sub>	g	Code
1/2" x 3/8"	16	28	35	23	15	11,4	10	RFV012038
3/4" x 3/8"	16	34	36	28	16,3	11,4	12	RFV034038
3/4" x 1/2"	16	34	39	28	16,3	15	15	RFV034012
1" x 3/8"	16	40	41	35	19,1	11,4	20	RFV100038
1" x 1/2"	16	40	44	35	19,1	15	24	RFV100012
1" x 3/4"	16	40	46	35	19,1	16,3	25	RFV100034
1"1/4 x 1/2"	16	52	48	44	21,4	15	37	RFV114012
1"1/4 x 3/4"	16	52	49	44	21,4	16,3	37	RFV114034
1"1/4 x 1"	16	52	52	44	21,4	19,1	40	RFV114100
1"1/2 x 1/2"	16	58	52	51	21,4	15	46	RFV112012
1"1/2 x 3/4"	16	58	50	51	21,4	16,3	47	RFV112034
1"1/2 x 1"	16	58	55	51	21,4	19,1	52	RFV112100
1"1/2 x 1"1/4	16	58	57	51	21,4	21,4	54	RFV112114
2" x 3/4"	16	70	60	64	25,7	16,3	80	RFV200034
2" x 1"	16	70	63	64	25,7	19,1	80	RFV200100
2" x 1"1/4	16	70	65	64	25,7	21,4	85	RFV200114
2" x 1"1/2	16	70	65	64	25,7	21,4	102	RFV200112



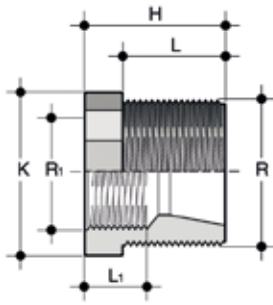

**RFV**  
**Fig. B** Reducer with BSP threaded male end (R) and BSP threaded female end (R1 reduced) (fig. B)

R x R <sub>1</sub>	PN	E	H	K	L	L <sub>1</sub>	g	Code
2"1/2 x 2"	16	-	56	80	30,2	25,7	155	RFV212200
3" x 2"	16	-	66	93	33,3	25,7	185	RFV300200
3" x 2"1/2	16	-	66	93	33,3	30,2	200	RFV300212
4" x 3"	16	-	79	118	39,3	33,3	500	RFV400300

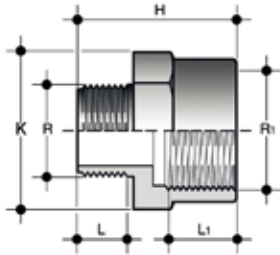

**IFFV**  
 Reducer: BSP threaded female end (R1), BSP threaded male end (R reduced)

R <sub>1</sub> x R	PN	H	K	L	L <sub>1</sub>	g	Code
3/4" x 1/2"	16	41	36	15	16,3	22	IFFV034012
1" x 1/2"	16	40,5	43	15	19,1	30	IFFV100012
1" x 3/4"	16	42	43	16,3	19,1	42	IFFV100034
1"1/4 x 1"	16	55	55	19,1	21,4	55	IFFV114100
1"1/2 x 1"1/4	16	62	65	21,4	21,4	102	IFFV112114
2" x 1"1/2	16	69	80	21,4	25,7	165	IFFV200112
2"1/2 x 2"	16	81	95	25,7	30,2	210	IFFV212200
3" x 2"1/2	16	93	110	30,2	33,3	360	IFFV300212
4" x 3"	16	106	130	33,3	39,3	500	IFFV400300

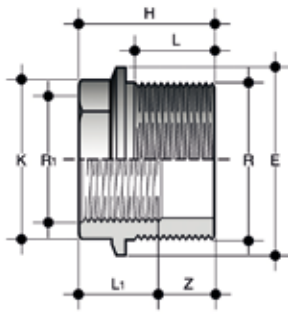

## DFV

Reducing bush with BSP threaded male end (R) and BSP threaded female end (R1 reduced)

R x R <sub>1</sub>	PN	E	H	K	L	L <sub>1</sub>	Z	g	Code
1/2" x 3/8"	16	28	24	23	11,4	15	12,6	7	DFV012038
3/4" x 1/2"	16	34	26,5	28	15	16,3	11,5	9	DFV034012
1" x 3/4"	16	40	30,5	35	16,3	19,10	14,2	17	DFV100034
1 1/4 x 1"	16	52	34	44	19,1	21,4	14,9	30	DFV114100
1 1/2 x 1 1/4"	16	58	35	51	21,4	21,4	13,6	30	DFV112114
2" x 1 1/2"	16	70	40	64	21,4	25,7	18,6	72	DFV200112

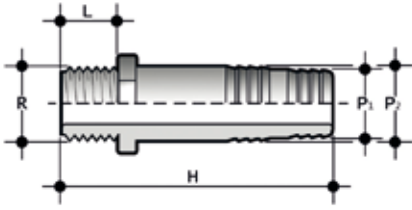

## AFV

Hose adaptor with BSP threaded male end

R x P <sub>1</sub> x P <sub>2</sub>	PN	H	L	g	Code
1/4" x 12 x 14	16	56	11	7	AFV014012014
3/8" x 16 x 18	16	58	11,4	14	AFV038016018
1/2" x 20 x 22	16	66	15	19	AFV012020022
3/4" x 25 x 27	16	81	16,3	30	AFV034025027
1" x 30 x 32	16	97	19,1	45	AFV100030032
1 1/4" x 40 x 42	16	104	21,4	85	AFV114040042
1 1/2" x 50 x 52	16	111	21,4	120	AFV112050052
2" x 60 x 64	16	123	25,7	180	AFV200060064

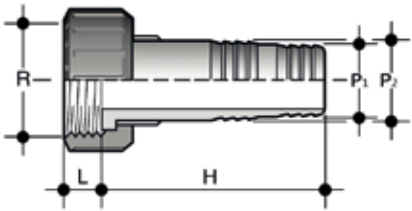

## ADV

Hose adaptor with BSP threaded female end (R) and EPDM flat gasket

R x P <sub>1</sub> x P <sub>2</sub>	PN	H	L	g	Code
1/2" x 12 x 14	16	56	14	15	ADV012012014
3/4" x 16 x 18	16	60	11,5	24	ADV034016018
1" x 20 x 22	16	67	11	35	ADV100020022
1 1/4" x 25 x 27	16	81	14	55	ADV114025027
1 1/2" x 30 x 32	16	97	16	80	ADV112030032
2" x 40 x 42	16	104	18	140	ADV200040042
2" x 50 x 52	16	111	16	180	ADV200050052
2 1/4" x 50 x 52	16	111	17,5	200	ADV214050052
2 3/4" x 60 x 64	16	123	20	300	ADV234060064